

Folding door fitting for 1 folding door with 2 panels  
**WingLine 780**





## Broad and strong

Attractive styling, fast assembly and load-bearing function – the WingLine 780 combines all these qualities in a very effective design.

A simple cabinet construction is sufficient, with no necessity to reinforce the top panel even with wider-type doors.

Unsurpassed also is the way in which its load-bearing function is teamed up with the benefits of rapid assembly: once assembled, the fitting is simply clipped into the runner profile where it is secured in place by two guide rollers.

- Suitable for use throughout the home
- With runner profile on top panel
- Runner with load-bearing function
- Optionally with bottom guide
- For wooden doors or wood framed doors
- Toolless quick-connect door assembly
- Cabinet design also suitable for hinged doors



### Technical brief:

- Door weight max. 10 kg/door panel
- Door panel height: max. 2200 mm
- Door panel width 400 - 500 mm
- Side-mounting with Interimat 9943 fast-assembly concealed hinge. Sensys hinge 8645i can be used on doors of up to 22 mm thickness.

# Folding door fitting WingLine 780 for 1 folding door with 2 panels

## ► System components

### Runner profile

- Screw-on version
- Length 2000 mm
- Aluminium self-colour



Order no.	PU
1 079 089	4

### Guide profile

- Predrilled
- Screw-on version
- Length 2000 mm
- Aluminium silver anodised



Order no.	PU
0 072 919	4

### WingLine 780 set ① with bottom guide

- For door heights up to 2200 mm

Mounting option	Order no.	PU
Left fitted	0 070 971	1 set
Right fitted	0 070 972	1 set

Right/left-hand set contains:



- Runner for fast assembly
- With 1 concealed hinge/spring
  - Nickel-plated steel/ grey plastic

Set pcs	①	Set pcs	②
2		2	

### WingLine 780 set ② without bottom guide

- For door heights up to 900 mm

Mounting option	Order no.	PU
Left fitted	9 080 212	1 set
Right fitted	9 080 213	1 set



- Drilling template for centre hinge
- For adjusting reveals from 1 mm to 4 mm

Set pcs	①	Set pcs	②
2		2	



- Folding door hinge
- For fast assembly
  - Screw-on version
  - Nickel-plated steel/ grey plastic

Set pcs	①	Set pcs	②
4		2	

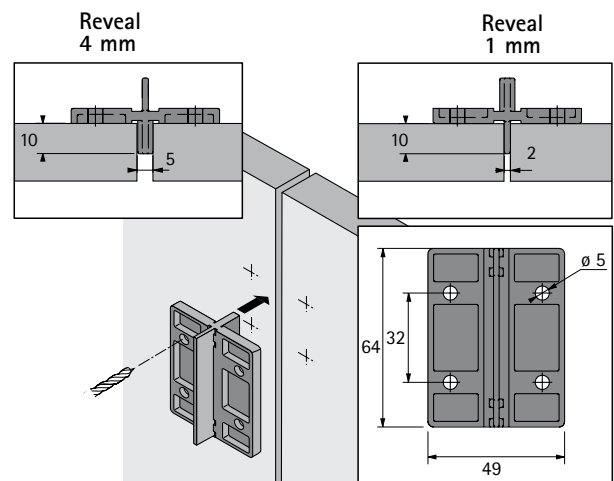

- Guide
- For fast assembly
  - With 3 guide rollers and 1 concealed hinge/spring
  - Nickel-plated steel/black plastic

Set pcs	①	Set pcs	②
1		-	

### Tungsten carbide drill bit ø 35 mm for runner and guide

- Shaft 10 mm, cylindrical
- For upright and hand drills only



Order no.	PU
0 046 071	1

Intermat 9943 or Sensys 8645i hinges/mounting plates should be ordered separately

# Folding door system

- ▶ WingLine 780 / loading capacity 10 kg
- ▶ Technical Information

## WingLine 780

### 2-panel door set

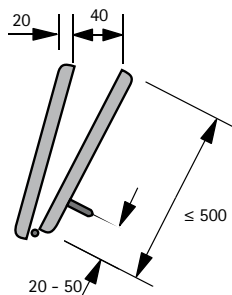

### 2-panel folding door

Panel width max. 1000 mm  
 Door weight/panel max. 20 kg  
 Door panel height max. 2200 mm

### Folding door with 2 panels

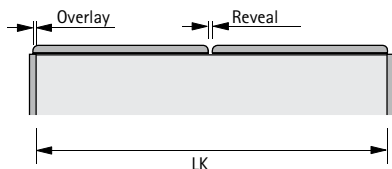
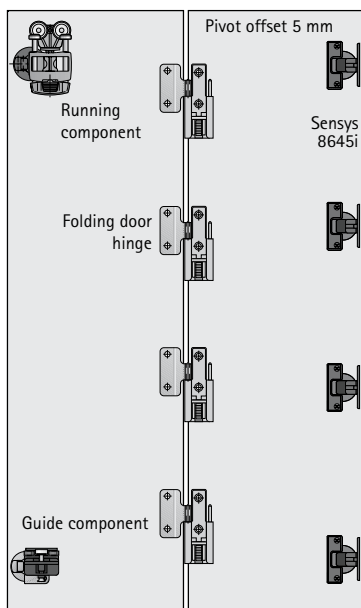

* B Hole spacing mm	13,5	14	14,5	15	15,5
Reveal mm	5	4	3	2	1

### Recommended door panel contours for reducing risk of crushing

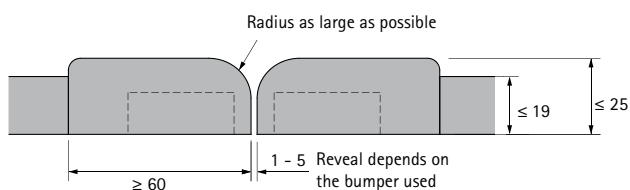
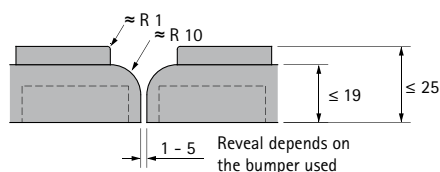
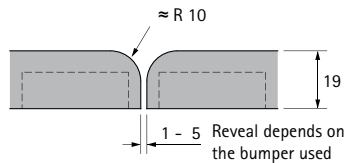

### Drilling pattern

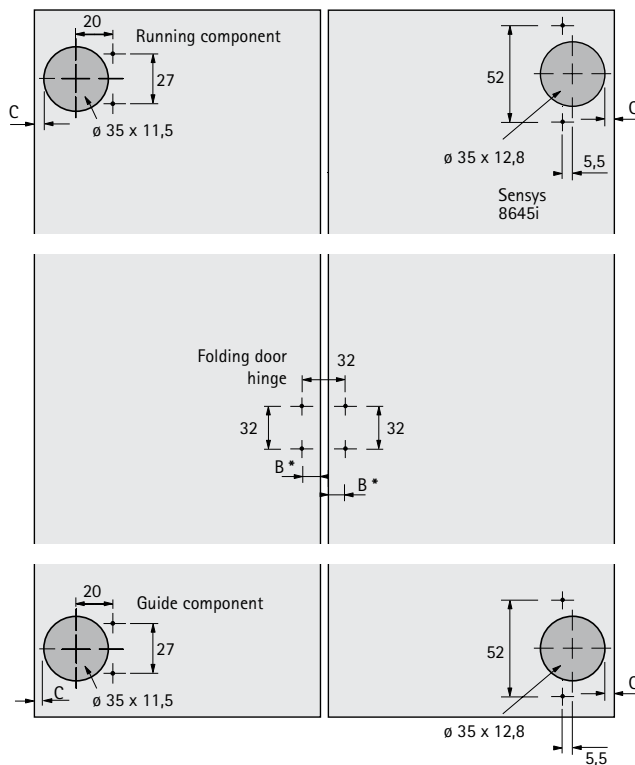

### Calculation of door width / door panels

Door width = inside cabinet width + (2 x overlay\*)  
 Door panel width = inside cabinet width - (1 x reveal)  
 + (2 x overlay\*) ÷ 2  
 \* Overlay: max. 15 mm, C dimension 5 mm

Hinges / mounting plates should be ordered separately